



Anton Paar

MCR

The Modular Compact Rheometer Series

::: Intelligence in Rheometry



MCR: Your future-proof rheometer.



**MCR rheometers offer you
one thing first and foremost:
An open range of possibilities.**



4-5

What does modularity mean?

6-7

Which features are available for easy, reliable MCR operation?

8-9

How do the synchronous EC motor's capacities work for you?

10-11

What are your advantages due to the instrument's design?

12-13

Which temperature control options do you require?

14-15

Which accessories are available to extend the MCR's functionality?

18-19

Specifications

16-17

Which measuring systems best suit your needs?

Look forward to your future applications...

MCR: The Modular Compact Rheometer Series

Modular.

MCR rheometry builds on your applications.

Whatever your rheological requirements are and will be in the future – MCR rheometers are efficiently and comfortably adapted to meet your needs. The intuitive application software and patented features like Toolmaster™, an automatic tool recognition and configuration system, make sure of this.

Changing a cone-plate for a concentric-cylinder measuring system is just as easy as integrating a new temperature device or extending your rheometer's testing capabilities with a wide range of application-specific accessories.

Compact.

MCR rheometry builds on your working day.

The space-saving MCR rheometers are designed with a specific focus on ease-of-use, with all components incorporated into one simply installed unit that easily fits on a standard laboratory table.

'Compact' use of your time is guaranteed: The patented TruGap™ system for automatic gap control, the T-Ready™ feature for controlling the actual sample temperature, and of course the speed and precision of the dynamic EC motor itself – these and other MCR characteristics ensure efficient rheological operation.

Rheometer.

MCR rheometry builds on technological innovation.

Benefit from rheological highlights such as the air-bearing-supported, synchronous EC motor, the dynamic TruRate™ sample-adaptive motor controller, the patented normal force sensor integrated in the air bearing, TruStrain™ real-time position control, continuously improved electronics and numerous other features that ensure the MCR series' world-renowned rheological peak performance.

Anton Paar's Modular Compact Rheometer series: From routine quality control applications to high-end research & development.

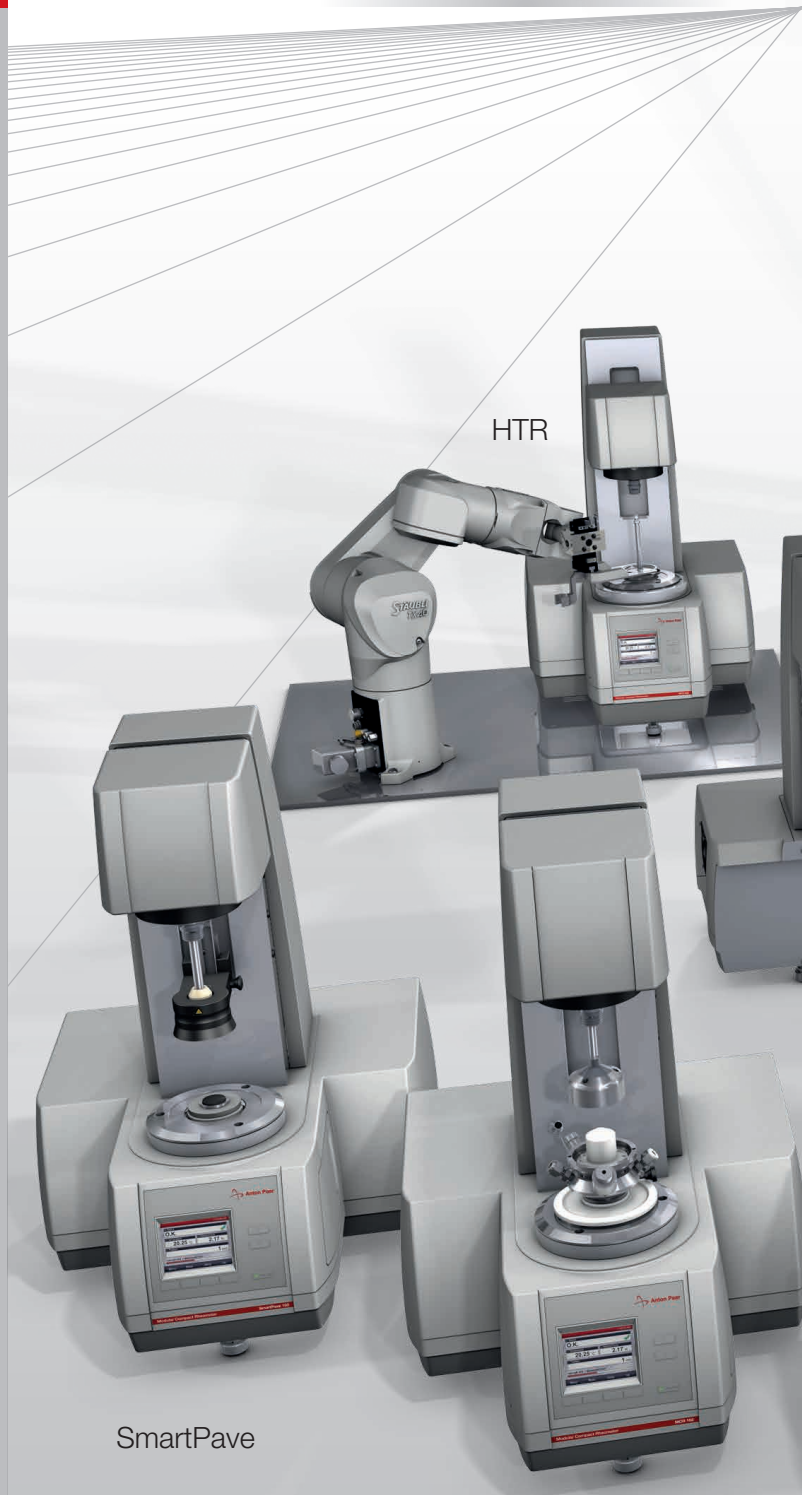

HTR

SmartPave

MCR 102



FRS

ASC

DSR

WESP

WSP

EC-Twist

MCR 52

MCR 302

MCR 502

MCR 702

New Paths for Your Applications The RheoCompass™ Software

Your rheometer opens up a constantly growing number of measurement opportunities. This calls for a navigation tool that gives you the complete overview as well as the exact insights you require: Anton Paar's new RheoCompass™ software, the most innovative and up-to-date rheometer software available on the market.

Designed for intuitive use, RheoCompass™ enables application-oriented template filtering, customized test and analysis definitions, highly simplified data retrieval and much more.

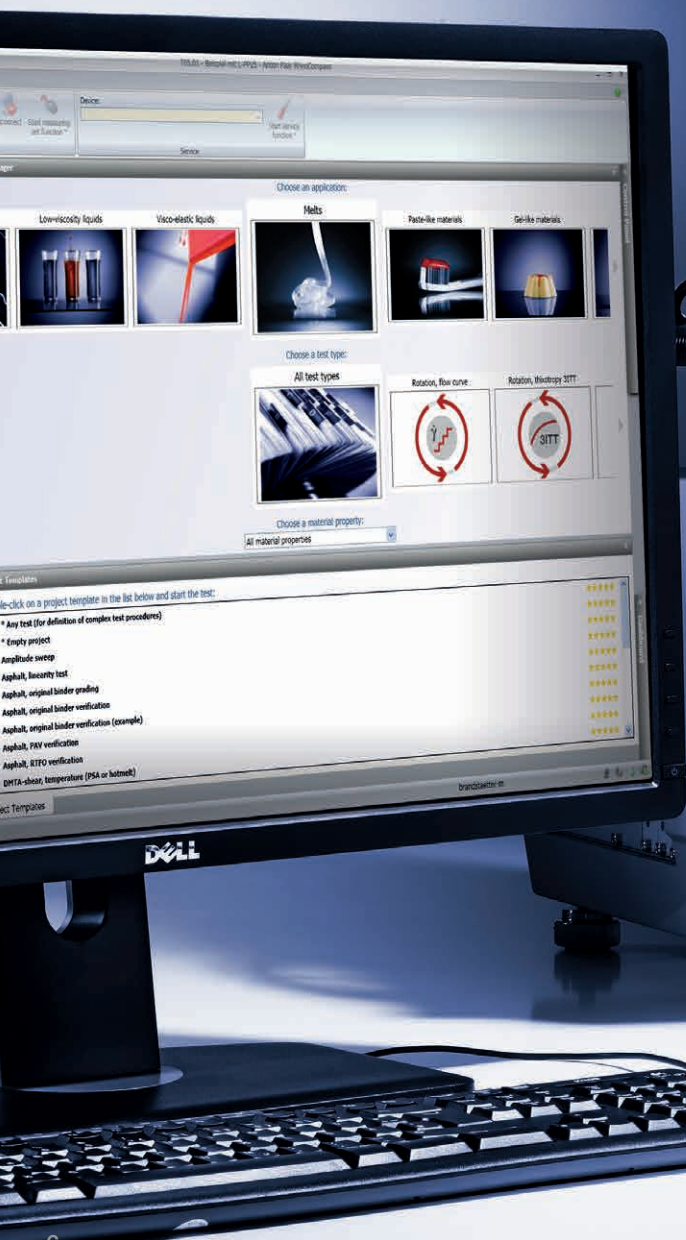

Patented Features for Comfort and Efficiency

Automatic recognition of measuring and environmental systems: Toolmaster™

The MCR's modular concept builds on the simple exchange of measuring systems and environmental systems. This exchange basically organizes itself in a very short time – as Toolmaster™ (US Patent 7,275,419) automatically does the work for you, without any selections in the software.

Toolmaster™ is the only completely automatic tool recognition and configuration system for rheology. It recognizes measuring and environmental systems as soon as these are connected to the rheometer. Transponder chips in each accessory's control cable and in the measuring system contain all relevant data, such as truncation, diameter, cone angle and serial number, and automatically transfer these to the application software. Error-free documentation and perfect traceability (21CFR Part 11 compliance) are guaranteed.

Easy fitting of measuring systems: QuickConnect

QuickConnect additionally offers you mechanical ease-of-use: The quick-fitting coupling allows one-hand connection of the measuring systems and ensures fast, convenient system changes without the use of a screwing mechanism.

Intuitive control of your device: MCR color display

With the MCR series' color display you can manage the complete sample preparation procedure directly at the instrument. The softkeys under the screen offer you the same functionality as a touchscreen, but without the risk of damaging or contaminating the screen in harsh working environments. Physical properties such as normal force, temperature and gap are displayed in a clearly arranged, accessible fashion.

Permanent control of the measuring gap: TruGap™

Errors in gap size due to thermal expansion or contraction directly influence the accuracy of results in parallel-plate and cone-plate measurements.

The patented TruGap™ system (US Patent 6,499,336) fully replaces these procedures: The gap is directly measured and precisely adjusted to the desired position independently of the temperature and thermal expansion.

TruGap™ measuring systems are based on a magnetic induction principle. An AC current flows through the primary coil in the lower plate, which induces a voltage in the secondary coil since the circuit is closed by an iron disk in the upper measuring plate. Based on this voltage, the gap size is consistently measured and adjusted.

Time-saving temperature certainty: T-Ready™

Rheological measurements are strongly influenced by temperature. Therefore, in addition to accurate temperature control, knowledge about the sample temperature equilibration is essential. The new T-Ready™ feature employs TruGap™ functionality to precisely determine when the desired sample temperature has been reached. Unnecessarily extended waiting times before tests are eliminated: T-Ready™ gives a green light so that the test can be started as soon as the desired sample temperature is reached.

The Key to Accuracy The EC Motor Technology

The air-bearing-supported synchronous EC motor (also called DC motor) is the key component of the MCR rheometer series.

Whether you perform zero-shear viscosity determinations of low-viscosity polymer solutions or measure highly viscous magnetorheological fluids at high shear rates and strains: The EC (Electrically Commutated) motor of the MCR series ensures accuracy across a wide viscosity range – from solids to liquids with viscosities lower than water.

The rotor of the EC motor drive is equipped with permanent magnets. In the stator, coils with opposite polarity produce magnetic poles. The magnets in the rotor and the stator coils attract each other, so that a rotating flux of current in the coil windings produces a frictionless synchronous movement of the rotor.

The torque of the motor is set and measured via the input current to the stator coils. Due to its unique design the EC motor features a linear relation between the torque and the input current to the stator coil, which is advantageous for precise torque control and measurement. These and other motor characteristics considerably benefit your rheological measurements.

Motor characteristics	Your rheological advantage
Instantaneous buildup of magnetic field, no magnetic induction	Fast response times for step rate and strain tests
No eddy current and heat production in motor	Permanent torque values up to 300 mNm
Linear relationship between electromagnetic torque and stator current, one single motor constant	Control and resolution of lowest speeds, deflection angles and torques, TruStrain™
Known constant magnetic field allows motor-controlled blocking	“Trimlock”: Motor-controlled blocking during sample trimming



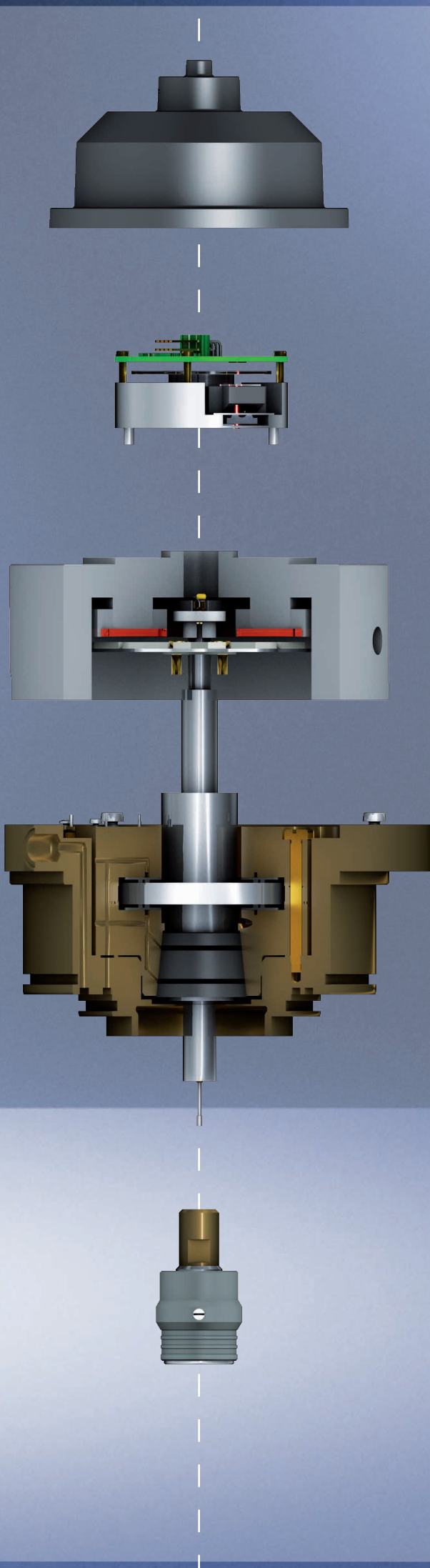

The optical encoder

The high-resolution optical encoder based on data oversampling technology enables the measurement and control of angular deflections down to 50 nanorad. Combined with TruStrain™ this provides the basis for comprehensive studies of samples with weak structures.

The speed of completely digital control

The use of the most recent processor technology in the MCR series increases the speed of data processing and increases the efficiency of transient tests. Due to the additional memory, important signals such as the torque and deflection angle are recorded and processed with higher signal density.

Anton Paar builds on a long-standing working experience with Digital Signal Processing (DSP) – with the MCR series being the first rheometers ever based on this technology. As a result of constant optimization, MCR rheometers are now also controlled with digital current sources. The low fluctuation and high performance of these sources further increases the accuracy of MCR torque measurement and control.

The air bearing

Two air bearings support the motor: A radial air bearing centers and stabilizes the shaft and the axial air bearing holds the weight of the rotating parts. This established air bearing technology is independent of external influences and therefore applicable without further electronic control.

Continuously optimized for rigidity, drift stability and robustness, the MCR rheometers' air bearing technology together with improved torque scanning enables low-torque measurements down to a minimum of 0.5 nNm.

The patented normal force sensor

The high sensitivity and increased sampling rate of the patented normal force sensor (US Patent 6,167,752) integrated in the air bearing enables normal force measurements during transient and steady-state tests as well as static normal force measurements, which are used for gap control and DMTA, tack or penetration tests. The sensor employs an electric capacity method, precisely converting extremely small deflections in the air bearing into the according normal force. Instead of enforcing additional travel, the natural movement already present in the air bearing is used to measure the normal force. The advantage of the sensor's location in the air bearing: Normal force measurements are available for all temperature devices and application-specific accessories. Whatever your application, the normal force sensor is always immediately functional.

Intelligent Design

Space to work: The housing

Ergonomics, functionality and durability were the central design goals of the compact MCR housing. All mechanical and electrical control components are incorporated into one single, simply installed unit that easily fits on a standard laboratory table. You are given sufficient space for sample loading, trimming and further preparation.

The mechanical self-alignment of all accessories ensures comfortable work with the modular MCR system. In addition, customized housing solutions are available, e.g. for adaptation to a confocal microscope.

Maximum rigidity: The frame

Due to the MCR rheometers' rigidity, changes in environmental temperature cannot influence the results of long-term tests. The new MCR series are built with a steel frame for optimized mechanical and thermal stability. In addition to the low elastic compliance of the steel itself, the IsoLign™ Piezo Flange actively compensates the residual compliance.

Compliance in check: The IsoLign™ Piezo Flange

The unique IsoLign™ Piezo Flange enables nanometer-scale gap size changes (10 nm) by three Piezo elements in the rheometer's bottom flange. This system provides additional measuring gap constancy – an especially vital feature for long-term measurements at low torques – and actively compensates the entire system's axial compliance in transient tests.

Connections

The modular concept of the MCR series is well reflected by the instrument's interfaces. The result: More options for flexible work.

- ▶ USB interface for direct communication with computer
- ▶ Ethernet interface for direct or network communication
- ▶ 4 analog interfaces for triggering external devices
- ▶ 2 auxiliary inputs for reading external devices
- ▶ Thermocouple interface for temperature reading
- ▶ Pt 100 interface for temperature reading

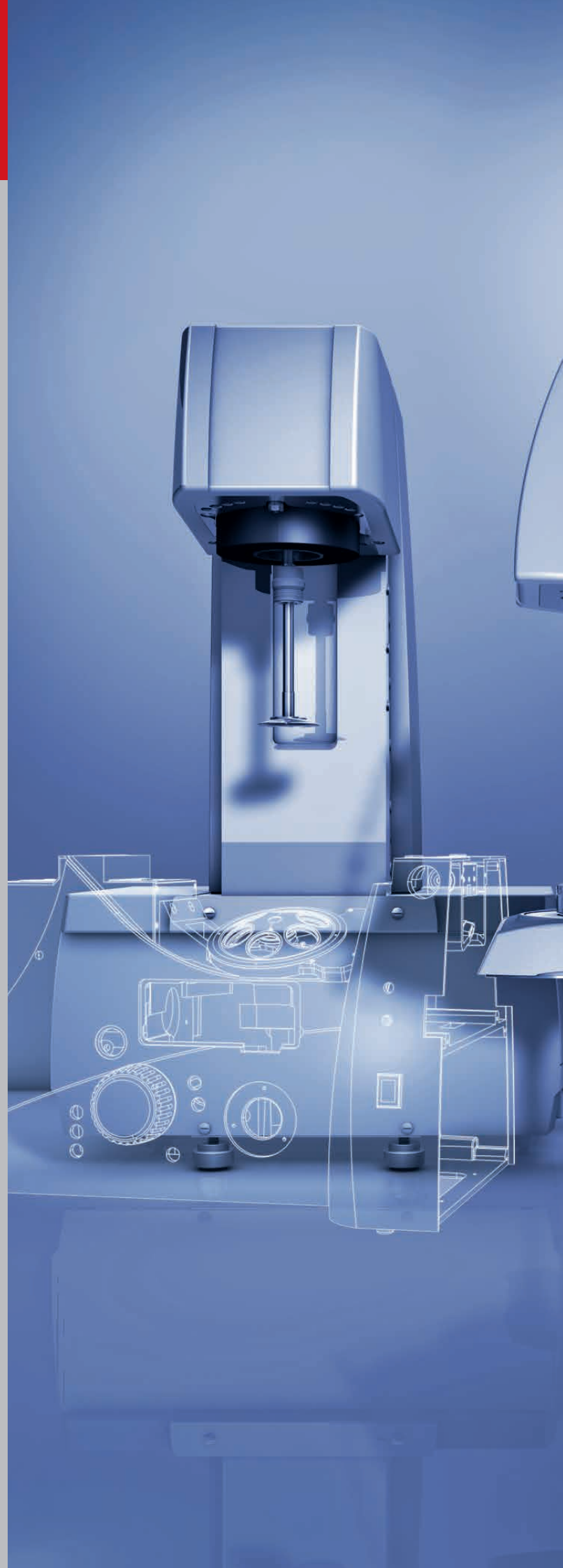



Intelligent Control

TruRate™

The MCR series' TruRate™ sample-adaptive controller intelligently adapts to the sample conditions at hand. Without prior information on the sample, and without any pre-testing, sample strains, shear rates or stresses are precisely controlled. The desired settings are achieved in minimum time; no additional software selections are required.

TruRate™ swiftly adjusts to the desired shear rate step or step in strain without overshoots – for accurate investigations of all kinds of samples.

TruStrain™

Strain-controlled oscillatory tests with common stress-controlled (CS) rheometers usually require a “guessing game”, including several oscillation cycles and subsequent adjustments, to reach the desired strain amplitude. TruStrain™ takes a different approach: Instead of amplitude control, it employs real-time position control based on the Direct Strain Oscillation (DSO) method. This ensures more efficiency and drift-free measurements at smallest torques and strains.

TruStrain™ adjusts to the desired strain directly on the sine wave, and the measuring system directly follows this required change in strain during each individual oscillation cycle. This means you are able to preset and control precisely sine-shaped strains both within the linear viscoelastic (destruction-free) range as well as in Large Amplitude Oscillatory Shear (LAOS) conditions. For close observation of intercycle processes, the application software optionally displays oscillatory waveforms and Lissajous diagrams.

TruStrain™ is especially valuable for oscillatory measurements on complex fluids such as gels, emulsions, suspensions, colloids, surfactant solutions, lubricating grease and foams.

All rheological parameters

The electric motor torque, the forcing frequency (set values) and the total moment of inertia or, alternatively, the deflection angle and the phase shift between the electric motor torque and the angle response (measured values), can be used to determine all rheological parameters.

Modular Temperature Control...

Anton Paar offers a wide range of modular temperature devices tailored to specific rheological requirements – from -150 °C to 1000 °C, from low-viscosity liquids to highly elastic solids, from traditional rheological

tests to DMTA measurements. All systems are easily exchanged within the MCR series and ensure virtually gradient-free temperature control for all applications. Make your first selection here.



C-PTD 200 C-PTD 180/AIR	C-ETD 200/300	PTD 200
-30 °C to 200 °C 0 °C to 180 °C	RT* to 200/300 °C	-40 °C to 200 °C
<ul style="list-style-type: none"> ▶ Cylinder ▶ Conduction ▶ Patented (US Patent 6,240,770) 	<ul style="list-style-type: none"> ▶ Cylinder ▶ Conduction 	<ul style="list-style-type: none"> ▶ CP/PP ▶ Conduction ▶ Convection ▶ Radiation ▶ Patented (US Patent 6,571,610)

Low-viscosity liquids

Viscoelastic liquids

Melts

Paste-like materials

Gel-like materials

Soft solids

Reactive systems

- ▶ Fully incorporated, truly Peltier-temperature-controlled system
- ▶ High heating and cooling rates
- ▶ No vertical temperature gradient in sample due to patented thermal transfer system
- ▶ Counter-cooling by air or fluid circulator
- ▶ Temperature control for pressure cells (C-PTD 200)

- ▶ Especially suited for measurements of low-viscosity samples at high temperatures
- ▶ High heating rates
- ▶ Ideal for use with pressure cell

- ▶ Fully incorporated, truly Peltier-temperature- controlled system
- ▶ TruGap™ support
- ▶ T-Ready™ feature
- ▶ Sliding rail for easy access and sample trimming
- ▶ Evaporation Blocker: prevents loss of volatile solvents
- ▶ Temperature-isolated hood (hand-warm for safe use)
- ▶ Isolated hood according to EN61010-1:2001

* Room temperature

...from -150 °C to 1000 °C

Anton Paar's temperature devices are based on the physical principles of conduction, convection and radiation.

CTD 180	ETD 400	CTD 620 CTD 600	CTD 1000
-20 °C to 180 °C	-130 °C to 400 °C	-130 °C to 620 °C -150 °C to 600 °C	-150 °C to 1000 °C
<ul style="list-style-type: none"> ▶ CP/PP/CC/DMTA solid and extensional fixtures ▶ Convection ▶ Radiation 	<ul style="list-style-type: none"> ▶ CP/PP ▶ Conduction ▶ Convection ▶ Radiation 	<ul style="list-style-type: none"> ▶ CP/PP/CC/DMTA solid and extensional fixtures ▶ Convection ▶ Radiation 	<ul style="list-style-type: none"> ▶ CC/PP ▶ Cylinder ▶ Convection ▶ Radiation

Solids		Solids	
<ul style="list-style-type: none"> ▶ Truly Peltier-temperature-controlled convection oven ▶ TruGap™ support ▶ T-Ready™ feature ▶ DigitalEye CCD camera function ▶ Modular configuration (DMTA torsion/tension, Photo DMTA/UV, reaction kinetics, SER extensional rheology) ▶ Humidity Option ▶ Temperature-isolated jacket (hand-warm for safe use) 	<ul style="list-style-type: none"> ▶ Ideal for measurements of tablets, granules and powders ▶ Sliding rail for easy access and sample trimming ▶ Temperature-isolated hood according to EN 61010-1:2001 (hand-warm for safe use) ▶ High heating rates ▶ Cooling by gas, water or liquid nitrogen 	<ul style="list-style-type: none"> ▶ Modular configuration (DMTA torsion/tension, Photo DMTA/UV, reaction kinetics, SER extensional viscosity) ▶ TruGap™ support ▶ T-Ready™ feature ▶ Digital Eye CCD camera function ▶ Pt 100 signal reflects true sample temperature ▶ Temperature-isolated jacket (hand-warm for safe use) ▶ Actively cooled jacket according to EN 61010-1:2001 ▶ Evaporation unit actively controls continuous flow of liquid nitrogen: most stable temperature signal for low-temperature applications ▶ Gas-Chiller Option for cooling without liquid nitrogen 	<ul style="list-style-type: none"> ▶ Most suitable for measurements of glass and metal melts ▶ Thermocouple signal reflects true sample temperature ▶ Temperature-isolated jacket (hand-warm for safe use) ▶ Actively cooled jacket according to EN 61010-1:2001 ▶ Evaporation unit actively controls continuous flow of liquid nitrogen: most stable temperature signal for low-temperature applications

Build on Your Rheometer: Application-specific Accessories

Structure Analysis

Gather sample structure information by combining these optical and dielectric methods with rheology.



**Rheo-Microscopy
(Fluorescence,
Polarized,
Non-Polarized)**



**Small-angle light
scattering (SALS)**



**Dynamic Optical
Rheo-Analyzer
(Birefringence,
Dichroism)**



**Small-angle
X-ray
scattering
(SAXS)**

Additional Parameter Setting

Employ these accessories to set additional parameters together with the temperature for rheological tests.



Pressure cells



UV Curing System

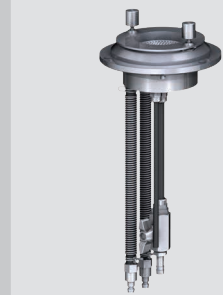

Immobilization Cell



**Magneto-
Rheological
Device**

Extended Material Characterization

These accessories transfer the MCR rheometer's measuring capabilities into other material characterization applications.



**Extensional
rheology**

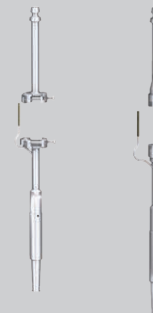

**Dynamic
mechanical
thermal analysis
(DMTA)**



Starch rheology

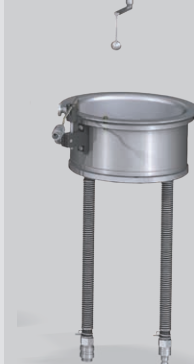

**Large-particle
rheology**

Obtain additional structure information, set additional parameters or employ the rheometer's functionality for further material characterization: This wide range of application-specific accessories is easily integrated into your MCR rheometer.



Small-angle neutron scattering (SANS)

Particle image velocimetry (PIV)

Polarized Imaging

Dielectro-Rheological Device (DRD)



Electro-Rheological Device

Humidity Option for CTD 180



Interfacial rheology

Tribology

Tribology Ball on three plates

Tribology Pin on disk

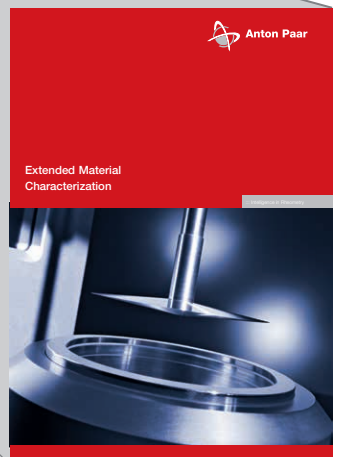

The Advantage of Diversity MCR Measuring Systems

The MCR measuring systems can be used with all temperature devices and are interchangeable within their category of accessories. For example, a PP25 parallel-plate measuring system can be used in all according LTD, PTD, ETD or CTD systems.

All geometry dimensions, safety limitations and calibration constants are saved in the Toolmaster™ chip located in the coupling of every measuring system. Made from diverse materials and featuring different surfaces and dimensions, all measuring systems are optimized regarding compliance, thermal expansion and thermal conductivity.

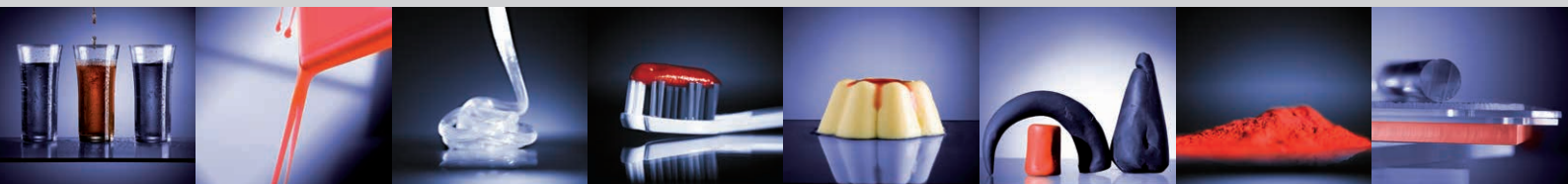

Low-viscosity liquids

Viscoelastic liquids

Melts

Paste-like materials

Gel-like materials

Soft solids

Reactive systems

Solids

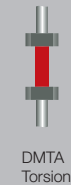
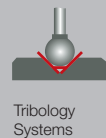

Measuring System Variants

With hundreds and hundreds of measuring systems, and their efficient combination with a wide range of environmental systems, there is barely any application that cannot be covered by an Anton Paar MCR rheometer.

The following nomenclature gives you an overview of available measuring system variants and how they are denoted.

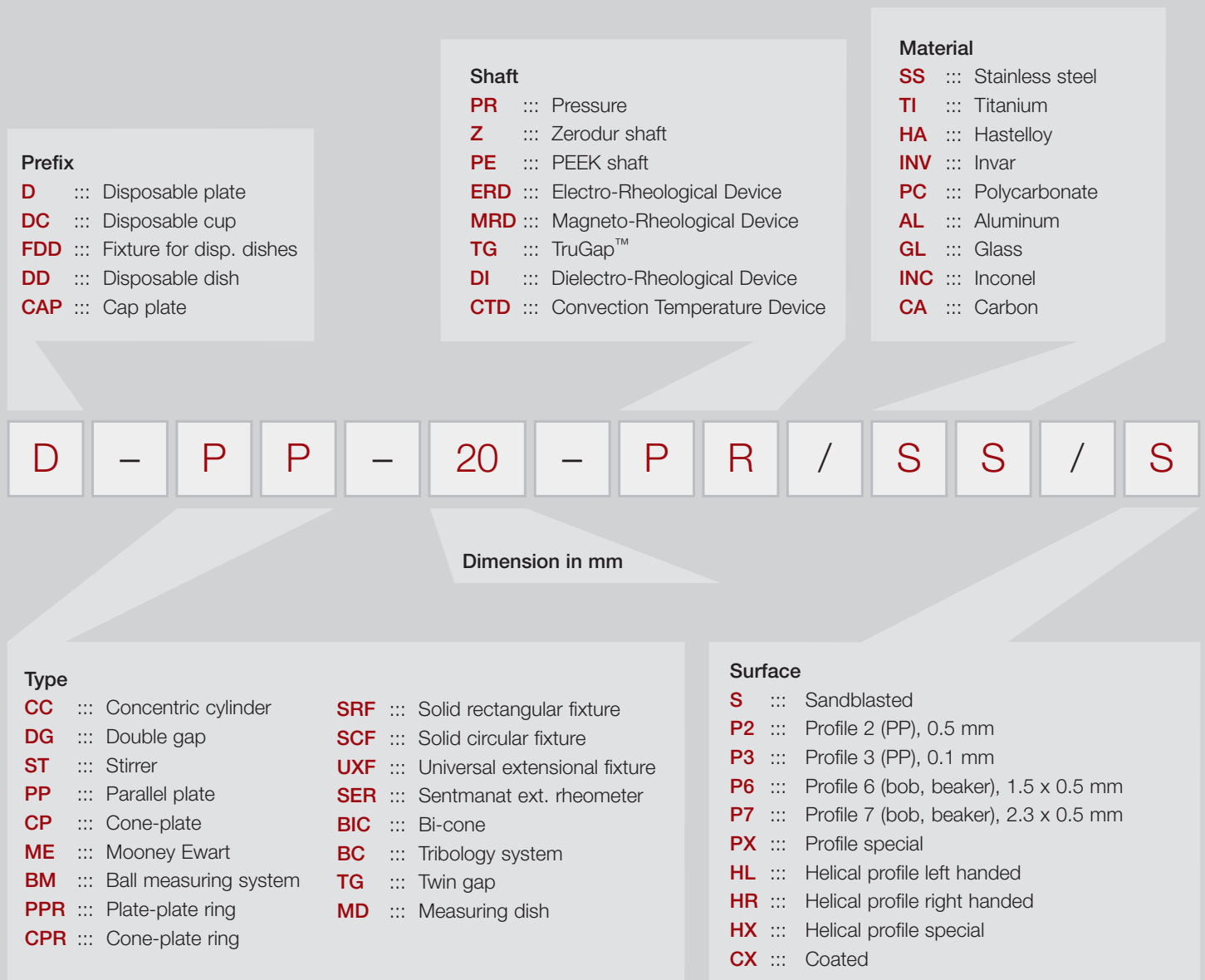

Pushing the Boundaries of Rheometry: MCR Rheometers Achieve Lowest Ever Torque

MCR rheometers are constantly being improved by a dedicated development team continuously furthering the rheometers' core components. Anton Paar now reports a significant breakthrough in the minimum torque levels that can be measured – see data below.

The technology developed for the groundbreaking TwinDrive™ system has been applied to the controller at the core of every MCR motor, and new production processes have been introduced. This means that the entire MCR series can now provide results of even greater precision, which is reflected in a new set of specifications.

Enhanced low-torque performance in shear-rate-controlled tests

A shear-rate-controlled rotational test in the figure below shows the certified viscosity of a standard oil within 5 % down to a torque of 1 nNm. This screenshot is taken directly from the software; every single point is displayed, showing the equidistance of point distribution in a precise shear-rate-controlled test without any extrapolation.

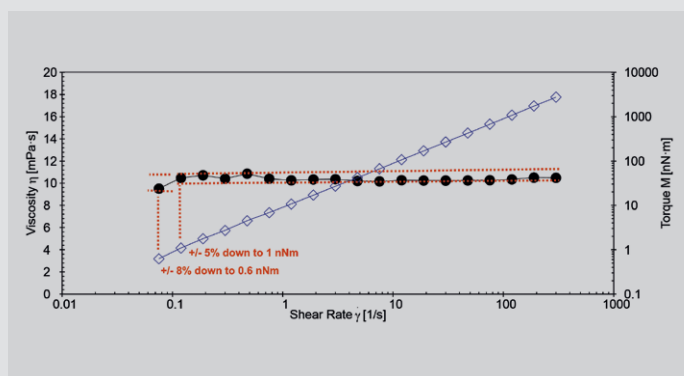

TruStrain™ control with increased data accuracy

The figure below shows a strain sweep in strain control down to a torque of 0.45 nNm. This snapshot from the software is also an actual measurement without any further processing or hidden data points. Therefore the data points are equidistantly distributed.

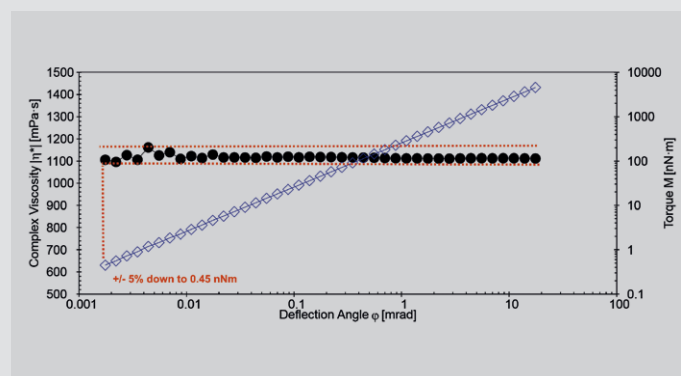

Measurements tell you more than words

The new specifications of Anton Paar's rheometers are shown by a single measurement. Come to one of Anton Paar's various demonstration labs worldwide – let experts measure your sample and discuss your specific application. Anton Paar is ready to help you fulfill your application requirements.

Specifications

	Unit	MCR 52	MCR 102	MCR 302	MCR 502
Bearing	-	Ball	Air	Air	Air
EC motor (brushless DC) with high-resolution optical encoder	-	✓	✓	✓	✓
Permanent torque (60 min), no signal drift	-	✓	✓	✓	✓
EC mode (controlled shear rate and shear stress)		✓	✓	✓	✓
Maximum torque	mNm	200	200	200	230 (300) ⁴
Minimum torque, rotation	nNm	250 µNm	5	1	1
Minimum torque, oscillation	nNm	-	7.5	0.5	0.5
Angular deflection, set value	µrad	1 to ∞	0.5 to ∞	0.05 to ∞	0.05 to ∞
Step rate, time constant	ms	-	5	5	5
Step strain, time constant	ms	-	10	10	10
Step time (rate, strain), 99 % of set value (all samples)	ms	-	30	30	30
Minimum angular velocity ⁽¹⁾	rad/s	10 ⁻⁴	10 ⁻⁸	10 ⁻⁹	10 ⁻⁹
Maximum angular velocity	rad/s	314	314	314	314
Minimum angular frequency ⁽²⁾	rad/s	10 ⁻³	10 ^{-7 (3)}	10 ^{-7 (3)}	10 ^{-7 (3)}
Maximum angular frequency	rad/s	628	628	628	628
Normal force range	N	-	0.01 to 50	0.005 to 50	0.005 to 50 (70N) ⁴
Dimensions	mm	678 x 444 x 586	678 x 444 x 586	678 x 444 x 586	753 x 444 x 586
Weight	kg	42	42	42	47
Toolmaster™, measuring system; Toolmaster™, measuring cell; QuickConnect for measuring systems, screwless; electronic trimlock for the measuring system	-	✓	✓	✓	✓
Digital Eye, Software video option and camera	-	○	○	○	○
Virtually gradient-free (horizontal, vertical) temperature control	-	✓	✓	✓	✓
CoolPeltier™, Peltier system with built-in cooling option requiring no additional accessories for counter-cooling	°C	-5 to 200	-5 to 200	-5 to 200	-5 to 200
Peltier-based convection oven, does not require LN ₂ for cooling	°C	-20 to 180	-20 to 180	-20 to 180	-20 to 180
Actively Peltier-controlled hood, Peltier technology	°C	-40 to 200	-40 to 200	-40 to 200	-40 to 200
Concentric-cylinder Peltier temperature control	°C	-30 to 200	-30 to 200	-30 to 200	-30 to 200
Maximum temperature range	°C	-150 to 1000	-150 to 1000	-150 to 1000	-150 to 1000
Pressure range	bar	up to 1000	up to 1000	up to 1000	up to 1000
Automatic gap control/setting, AGC/AGS	-	✓	✓	✓	✓
TruGap™ for in-place measurement and control of the gap	-	✗	✓	✓	✓
TwineµD™-ready	-	✗	✗	✗	✓
Direct strain/stress amplitude controller	-	✓	✓	✓	✓
TruRate™	-	○	○	✓	✓
TruStrain™	-	✗	○	✓	✓
Normal force and velocity profiles, tack, squeeze	-	✗	○	✓	✓
Raw data (LAOS, waveform, ...)	-	✗	○	○	✓
IsoLign™ Piezo Flange	-	✗	✗	✗	✓
With Exposed Support Plate (WESP), Without any Support Plate (WSP)	-	✗	✗	○	✗
Connections		USB, Ethernet, 4 analog interfaces, 3 auxiliary inputs, Pt 100 and thermocouple interfaces			

¹⁾ Depending on measuring point duration and sampling time, practically any value is achieved
²⁾ Set frequencies below 10⁻⁴ rad/s are of no practical relevance due to the measuring point duration > 1 day
³⁾ Theoretical value (duration per cycle = 2 years)
⁴⁾ Rheometer EC-Twist

Legend: ○ optional

